

GENPOWER[®]

GENERATOR

GBG 15I GASOLINE GENERATORS USER AND MAINTENANCE MANUEL



DEAR GENPOWER GENERATOR SET USER;

Welcome to Genpower Family!

Thank you for choosing Genpower generator and hope your works will not be unfinished.

Genpower generator sets are produced in compliance with ISO 9001:2000 Quality Management System and “CE” norms and in an environment-friendly way compatible to ISO 14001:2004 Environment Management System.

Our generators are delivered to our end users by being subjected to a careful quality control and tests which are applied in every stage of production. We are attempting to continuously improve our product and provide a better service for you, with our staff specialized in their field of interests and in modern factory facilities.

Please read the operating manual carefully before initial starting of generator set and also recommend you have it be installed by our authorized service in order to avoid from any unfinished matter.

This operating manual, for engine service–maintenance and alternator service–maintenance books are delivered together with generator set.

This operating and maintenance manual was prepared in order to ensure users to easily handle the generator and help them how they are going to make its maintenance. This is not a workshop repair manual.

The generator is under guarantee for **2 (two) years or 1500 operating hours** provided the use of it in accordance with the matters stated in operating and maintenance manuals. Any repair or replacement of parts caused by any modification held on the generator without giving consent of the original manufacturer or by use of non-original parts are excluded from scope of guarantee.

We recommend you to make a periodical maintenance agreement with our authorized services which provide continuous service for 7 days/ 24 hours in order to have much more performance and prolonged life -cycle of generator.

Please comply with attention and warning indicators on the generator set and take necessary safety measures mentioned in this manual for your safety and your surrounding lives.

Information included in this manual may not contain all features belonging to the generator.

Genpower has the right of making any amendment to improve the product quality without notifying.

GENPOWER GENERATOR

“Keep this manual for later assistance”

GENPOWER GENERATORS UNIQUE SUPERIOR FEATURES AND ADVANTAGES

- ◆ **Half A Century Old Experience in Generator Production**

- ◆ Low-level Noise

- ◆ **Advanced Technology and High-Quality Diesel Engines**

- ◆ Low-level Exhaust Emission

- ◆ **Advanced Technology and High-Quality Alternators**

- ◆ Low Operating Costs

- ◆ **Flexible Control Card Suitable for All Kinds of Applications**

- ◆ Low Fuel Consumption

- ◆ **Reliable and High-Quality Technology**

- ◆ Low Oil Consumption

- ◆ **Compact, Silent, Patented Design Canopy**

- ◆ Tropical, 50 °C Radiator

- ◆ **Compatible to Heavy Duty Conditions**

- ◆ Water and Particulate Separated Fuel Filter

- ◆ **First Class Product Support**

- ◆ Durability

- ◆ **Abundant and Reasonable Cost Spare Parts**

- ◆ Global Network in Service and Maintenance

IMPORTANT GENERAL INFORMATION

Generator Rating Definitions:

Genpower generators are produced in compliance with; TS ISO 8528-1, 8528-4, ISO 8528-5, BS500, ISO 3046/1:1985, IEC 60034, NEMA MG-1.22, BS5514/1 standard.

Standby Power (ESP) is defined as the maximum power available during a variable electrical power sequence, under the stated operating conditions, for which a generating set is capable of delivering in the event of a reliable utility power outage. over 24 hours of operation shall not exceed 70% of the ESP rating. Under the condition of generator`s periodic maintenance has done in compliance with manufacturers maintenance procedures, total operating time at 70% ESP rating shall not exceed 200 hours/year. For applications supporting an unreliable utility service, the Prime Power (PRP) rating should be used.

Prime Power (PRP) is defined as being the maximum power which a generator set is capable of delivering continuously whilst supplying a variable electrical load when operated for an unlimited number of hours per year. The permissible average power output over 24 hours of operation shall not exceed 70% of the PRP. Total operating time at 100% PRP rating shall not exceed 500 hours/year. At 12-hour operating time %10 overloading can be done in one-hour zone, total operating time at overloading with 10% PRP rating shall not exceed 25 hours/year.

Limited Continuous Power (LTP) Under the condition of generator`s periodic maintenance has done in compliance with manufacturers maintenance procedures, total operating time at %100 LTP rating shall not exceed 500 hours/year. No overload capability is available for this rating.

Continuous Power (COP) is defined as being able to supply utility power at a constant 100 percent load for an unlimited number of hours per year. No overload capability is available for this rating.



Recommended to follow these instructions in selection and operation of generator;

- Generator, In Continuous Power, under the condition of generator`s periodic maintenance has done in compliance with manufacturers maintenance procedures and is used original spare parts and oil in compliance with manufacturer`s catalogues, may operate maximum %70 load at PRP.
- Generators shall not operated under the level of %50 at PRP rating. This may cause extreme oil consumption in engine, after in a short while permanent and unrecoverable damages may occurs.
- Dual or triple sync, equally aged and with fault redundancy systems should be chosen if the power output necessity is 1000 kVa and higher.



ATTENTION! NEVER LOAD GENERATOR TILL TEMPERATURE OF WATER REACH 60 °C IN MANUAL OPERATED GENERATORS.

1. PART: SAFETY MEASURES

1.1. INTRODUCTION

* Generator groups produced by our company have been designed and conceived by prioritizing all sorts of safety of lives and property.

* Generators should be installed and used in accordance with maintenance and operating rules stated in this catalogue both in terms of using the generator economically for a long-term and ensuring continuous safety of life and property. Required safety measures should be taken in advance during the installation, usage and maintenance. Safe operating responsibility of the generator set belongs to user who is using and maintaining it. Provided that instructions, methods and safety rules in this manual are complied with, risk of accident will decrease.

* Otherwise, unexpected defects and accidents which may result within serious injured and death of people and damage on the equipment. Please have your generator used and maintained by well-trained people who issued or authorized persons in order to prevent these occasions.

* Please plan any part, machine or engine you are operating in a way to ensure easy access to every point. Take pre-safety measures about how you can avoid from exposure to occasions like touching with rotating parts, burning and cut with sharp edges while checking out the engine. Ensure that covers of turbo compressor driving shaft, pump shaft, fan belts and winglets among engine components are fitted.

* Never make any maintenance or repair while the generator set is operating. Turn off the generator and take all safety measures before any maintenance initiated.

* Never have unauthorized persons repaired and maintained, this will cause damage in your generator and also be out of from scope of guarantee. We recommend you to use our authorized services providing 7/24 service.

* This generator produces heat when running. Temperatures near exhaust can exceed 65 °C (150 °F).

1.2. **ATTENTION! DON'T DO THE FOLLOWINGS:**

* Do not carry the generator on its side or in an inclined position during transportation. Oil or fuel may overflow into the air filter and wets the filter, and the filter will not work if it does not absorb enough air. If this happens, remove the filter, wash it until the oil or fuel is clean, dry it and put it back or replace it with a new one.

* Don't start the engine indoors. Exhaust gases are odorless and can be deadly as they contain carbon monoxide.

* Do not insert your hands and feet into moving or rotating parts.

* Do not store, pour or use gasoline near open flames or appliances such as stoves, water heaters or sparking devices.

* Do not refuel in places such as poorly ventilated rooms. Do this in an open area.

* Do not refuel while the engine is running. Allow the engine to cool for 20 minutes before filling the gas tank. Store fuel in safe containers.

* Do not remove the fuel tank cap while the engine is running.

* Do not start the engine in the presence of gasoline odor or other explosive conditions.

* Do not start the engine if it is overflowing or dripping gasoline. Move the generator away from the stream and block ignition until the gasoline has evaporated.

* Do not carry the generator from one place to another with gasoline in the tank.

* Do not smoke while refueling.

* Do not run the engine at excessive speed. This can lead to accidents.

* Do not change the engine speeds selected by the manufacturer.

* Do not control sparking (ignition) by removing the spark plug or spark plug wire. Use a tester for this job.

* Do not rotate (run) the crankshaft by removing the spark plug.

* Do not hit the flywheel with a hard object while it is operating, it may break. Use the correct tool for servicing.

* Do not run the engine without a muffler. Check frequently and replace if necessary. If there is a muffler deflector, check it periodically and replace it with the correct deflector if necessary.

* Do not run the engine with flammable materials around the muffler.

* Do not use generators without spark arresters in the muffler in forest, woodland or lawn environments. For effective operation, the spark arrester must be serviced by the user

* Do not touch the hot muffler, cylinder or cooling fins as this will cause burns.

* Do not operate the engine without the air cleaner, air cleaner cover and/or carburetor air intake cover.

* Never connect the generator to a building's electrical system without a qualified electrician.

* Do not use generator in rainy conditions.

1.3. **ATTENTION! DO THE FOLLOWINGS:**

* When the operation of the generator is completed; turn off the generator. Then, make sure to **close the fuel tap** at the bottom of the tank. If you do not turn off the tap; since the tank is at the top and has a large volume, the gasoline flows and drowns the carburetor. Remember to open the fuel tap before restarting. When the generator working is finished, close the fuel tap again.

* Clean the cylinder cooling fins and speed governor parts as they can affect engine speed.

- * Pull the starter cord slowly until you feel resistance. Then quickly pull the handle to avoid kickback and hand injuries. For safety reasons, make sure that there is no one around the starter.
- * Check the muffler periodically to make sure it is working properly. Worn, leaking muffler should be repaired or replaced.
- * Use fresh gasoline. Stale fuel can cause gumming and leaking in the carburetor.
- * Check the fuel connections and gaskets for cracks and leaks. Renew if necessary.
- * Always keep the fuel cock closed when you do not start the generator.
- * Have sufficient amount of **fulfilled** fire **extinguisher** present near to the generator.
- * Always ground the generator before using it.
- * Generator should only be plugged into electrical devices, either directly or within an extension cord.

1.4. MOVING COMPONENTS AND IRRITATING MATERIALS:

- * As a general maintenance rule; ensure gasoline engine is on STOP state or its covers are installed on it. Never operate engines **without protection guard** which are disassembled except the case that exceptional maintenance and settings must be performed.
- * Coming close to an operating engine is a safety risk. Remember wide and loose clothes, long hairs may cause serious accidents by being put on rotating components.
- * Putting tools or equipment down on operating engine due to incaution may lead to serious injuries in case of close contact to the engine.
 - * Avoid from touching with operating engine exhaust system.
 - * Install materials for safety and protection purpose disassembled during the service on their places before **starting** the engine.
 - * Avoid contact gasoline, oils, cooling water and accumulator electrolyte used in the engine with your **bare** body.
 - * Wear **protection** gloves and oil proof clothes while engaging with these works.
 - * Oils, especially used oils **influence under the skin and so** may lead to irritation and eczema on skin.
 - * Thoroughly wash your skin after contact with oil and use protective creams.
 - * Hot oils may cause burns. Do not touch hot oil, your skin may burn. Ensure there is no pressure in the system before starting to work while operating with the lubrication system.

1.5. EXHAUST GASES:

- * Breathing exhaust gases is toxic and dangerous. Operate the generator on OPEN air or in environments with a good air circulation.
- * Take attention that exhaust gas outlet points do not **exhaust** to human **living** areas or near to air intake channels.
- * Do not operate the generator in the exhaust system having gas **leakage**.

1.6. ELECTRIC SHOCK AND FIRST AID:

1.6.1. What Is First Aid?

In the event of an accident or life-threatening situation, the treatment without medicines is called first aid until the assistance of the medical staff is provided, in order to prevent life from getting worse or worse.
FIRST AID APPLICATION IS ABSOLUTELY NOT USED.

1.6.2. What Is The Purpose In First Aid?

- * Protection and maintenance of life
- * Prevent deterioration of the situation
- * Facilitate the healing process.

1.6.3. What Are The Features And Responsibilities Of The First Aider?

- * He must be calm and unhurried.
- * Keep the patient calm.
- * Determine whether there is a danger that evaluates the environment.
- * Do not endanger the safety of his / her life.
- * Organize the people in charge to inform health institutions, fire and security.
- * Evaluate the condition of the patient and begin appropriate first aid.
- * Ensure that the patient arrives at the health facility as soon as possible.

1.6.4. What are the basics of First Aid?

- * Opening of the breathing passage
- * Correcting the respiratory system.
- * Ensuring activity of the circulatory system.

1.6.5. First Aid In Electric Shock

- * First ensure your own (first-aider) safety.
- * Turn off the source of electricity, if possible.
- * If not, move the source away from you and the person, using a dry, nonconducting object like plastic or wood.
- * Begin CPR if the person shows no signs of circulation, such as breathing, coughing or movement.
- * Apply a bandage. Cover any burned areas with a sterile gauze bandage.

1.6.6. First Aid for Carbon Monoxide Poisoning

- * The patient is immediately moved to fresh air.
- * Deep breathing is carried out in the fresh air.
- * CPR is applied to patients who are unable to breathe or breathe.
- * Cover the top of the body to prevent the patient from chilling.
- * The patient shall be sent to the health center immediately.

1.6.7. First Aid for Bleeding

- * If the wound is on the arm or leg, raise limb above the heart, if possible, to help slow bleeding.
- * Apply direct pressure on the cut or wound with a clean cloth, tissue, or piece of gauze until bleeding stops.
- * Apply a tourniquet if the bleeding is severe and not stopped with direct pressure in 5 minutes.

1.6.8. First Aid for Minor Burnings

- * **Cool the burn.** Hold the burned area under cool (not cold) running water or apply a cool, wet compress until the pain eases.
- * Remove rings or other tight items from the burned area.
- * Don't break blisters.
- * **Bandage the burn.** Cover the burn with a sterile gauze bandage (not fluffy cotton)

2. PART: BEFORE STARTING:

- * **Genpower Generators** have been produced in international standards.
- * There is an oil level sensor in the generators to prevent damage to the engine in case of oil shortage. When the oil level falls below a certain level, this sensor does not allow the generator to operate.
- * The oil capacity of the engine crankcase is **0.4 liters**.
- * Verify engine oil level is correct.
- * Verify fuel level is correct.
- * Verify unit is secure on level ground, with proper clearance and is in a well ventilated area.
- * Use **20W50** oil which also used in gasoline vehicles as oil.
- * Each generator has a group identification plate. Serial number, qualifications, weights and manufacturing date of generators are written on this group plate. Use this serial number in spare parts, repair claims, interviews and at your demands.
- * It is recommended to use high quality detergent oils classified as SE, SF, SD or SC. Detergent oils keep the engine clean and prevent gumming and deposits. Nothing should be added to the recommended oil. The viscosity of the lubricating oil used should be selected in accordance with the ambient temperature range in which the engine operates.
- * The exhaust system must be property maintained. Do not alter or modify the exhaust system as to render it unsafe or make it noncompliant with local codes a /or standards failure to do so will result in death or serious injury.
- * Risk of fire. Do not use generator without spark arrestor installed. Failure to do so could result in death or serious injury.
- * Hot surfaces when operating machine do not touch hot surfaces keep machine away from combustibles during use. Hot surfaces could result in severe burns or fire.

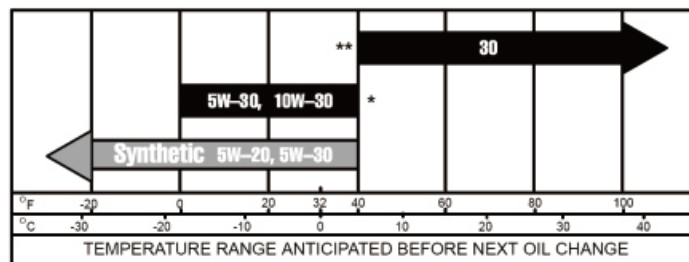

Figure-1

2.1 FILLING OIL:

- * The generator is shipped without oil in the engine. Add oil slowly and verify oil level often during filling process to ensure overfilling does not occur.
- * Place generator on a level surface.
- * Clean area around oil fill and drain plug.
- * Use petroleum based oil for engine break-in before using synthetic oil.
- * Open the access panel, remove oil dipstick as shown in **Figure 2**.
- * Remove oil fill cap and wipe dipstick clean. **See Figure 2**.
- * To check oil level, remove funnel and insert dipstick into oil filler neck.
- * Insert funnel into oil fill opening. Add recommended engine oil as necessary. Climate determines proper engine oil viscosity. See chart to select correct viscosity.
- * Remove dipstick and verify oil level is within safe operating range. **See Figure-3**.
- * Install oil fill cap /dipstick and hand tighten.

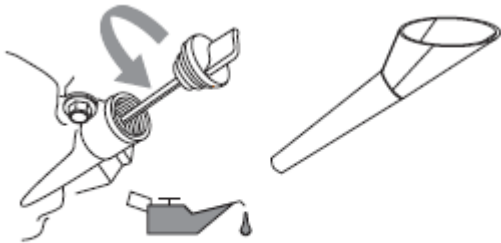

Figure -2 Oil Fill With Funnel

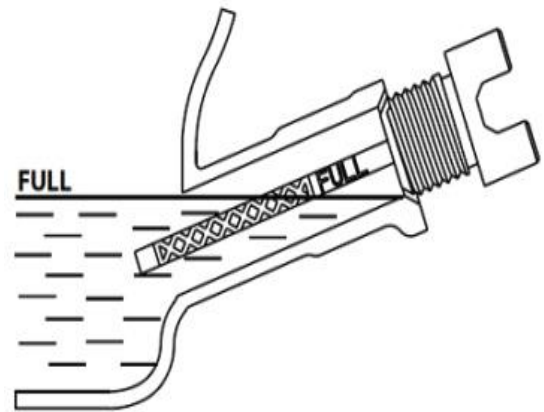

Figure-3 Safe Operating Range

2.2 CHECKING THE OIL LEVEL:

- * Inspect engine oil level prior to each use or every 8 hours of operation.
- * Put the generator on a flat surface.
- * Clean area around oil fill, and oil drain plug.
- * Remove oil fill cap and wipe dipstick clean. **See Figure 4**.
- * To check oil level, insert dipstick into oil filler neck without screwing it in. **See Figure 4**.
- * Remove dipstick and verify oil level is within safe operating range.
- * Add recommended engine oil as necessary.
- * Verify oil level often during filling process to ensure overfilling does not occur.
- * Replace oil fill cap and hand-tighten.
- * Some units have more than one oil fill location. It is only necessary to use one oil fill point.

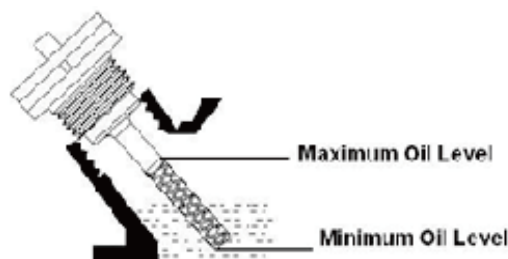

Figure-4

2.3 GASOLINE RECOMMENDATIONS:

- * Your generator runs efficiently with all gasoline used for automotive.
- * It is recommended to use gasoline with an octane rating of at least 77. Do not mix oil with fuel.
- * Use clean, fresh and unleaded gasoline.
- * The capacity of the fuel tank is 1 gallon.
- * Do not fill the fuel tank to the very top. Gasoline will expand and spill over during use even with the fuel cap in place.
- * Purchase the amount of fuel to be used in the 30-day period. This ensures fuel freshness and the required fuel viscosity according to the season.
- * When unleaded petrol is not available, leaded petrol can be used. Unleaded gasoline prolongs valve life as it reduces combustion residues.
- * Do not use gasoline containing alcohol. If alcohol is to be used with the fuel, the gasoline should not contain more than 10% ethanol and should be drained when the engine is not in use.
- * Do not open the fuel cap while the engine is running.

2.4 RECOMMENDATIONS FOR AN EFFICIENT PERFORMANCE:

- * Keep the generator flat while filling, storing and operating with oil and fuel.
- * Do not use pressurized starting fluid.
- * Use oil suitable for the temperature.
- * Do not start the engine with a low oil level.
- * Run the generator at no load (idle).
- * Use fresh fuel.
- * If the engine is cold, make sure to adjust the choke fully.
- * A hot engine requires less choke than a cold engine.

3. PART: MAIN PARTS OF THE GENERATOR

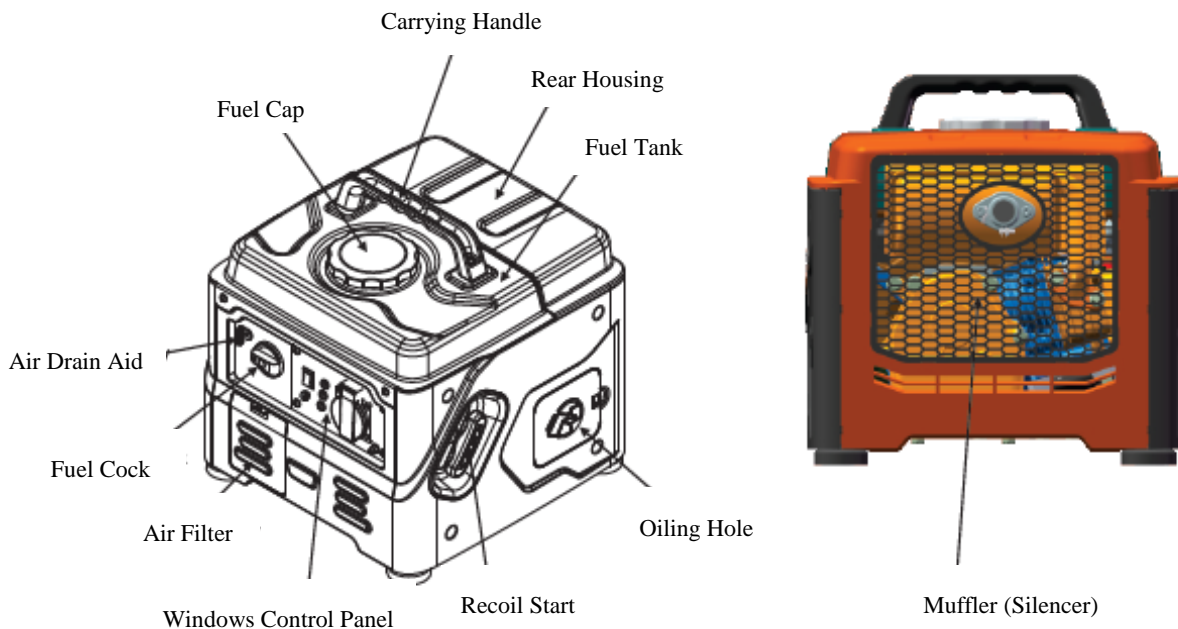
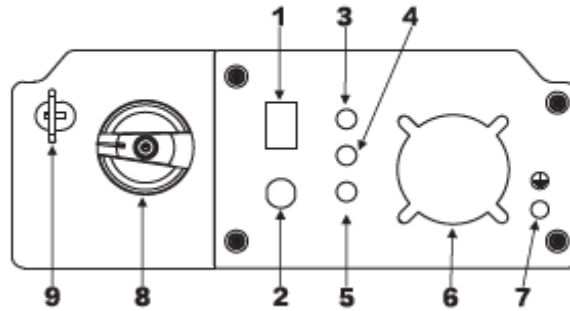

Figure-5 Main Parts Of The Generator

TABLE-1 Generetor Components



1	Engine Switch
2	Reset SW
3	Oil Alarm Lamp
4	Overload Light
5	Output Indicator
6	AC 230 V
7	Grounding Location
8	Fuel Cock
9	Air Drain

TABLE 2. Product Specifications

	MODEL NO	GBG 15i
Engine	Type	OHV, Single Cylinder, Forced Air Cooled, Four Stroke
	Displacement	60
	Ignition	TCI
	Fuel Tank Capacity(L)	5
	Oil Capacity(L)	0.4
Generator	Frequency(Hz)	50
	Voltage(V)	230
	Rated Output Power(kVA)	1.3
	Max. Output Power(kVA)	1.5
Generator Set	Lenght(mm)	338
	Width(mm)	330
	Height(mm)	342
	Phase	Single Phase
	Net Weight(Kg)	13

3.1 OFF/ ON / CHOKE SWITCH:

- * This controls the ON / OFF functions choke and fuel valve operation. See **Figure-6**
- * The “OFF” position (1) stops the engine and shuts off fuel flow.
- * The “ON” position (2) is for normal operation and to gradually reduce the use of the choke.
- * The “CHOKE” position (3) switches the fuel valve on to start the engine.
- * The “CHOKE” is not required to start a warm engine.

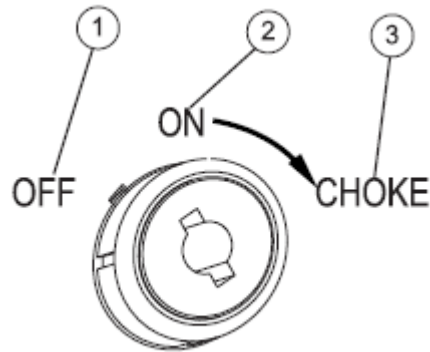

Figure-6 Switch (Example)

3.2 USB OUTLETS:

- * The 5 VDC, 1 / 2.1 Amp USB outlet allows charging of compatible electronic devices.

3.3 ECONOMY SWITCH:

- * The economy switch has 2 modes of operation:
- * **ON:** The Quietest mode and best when running appliances or equipment that are resistive loads (non-motor starting), (example: TV, video game, light radio).
- * **OFF:** Best when running a both inductive (motor-starting loads) and resistive (non-motor starting loads), especially when these loads are turning on and off (example: RV, air conditioner, hairdryer).

3.4 GENERATOR STATUS LIGHTS: See Figure-7.

- * **OVERLOAD LED (RED):** Indicates system overload (2). During motor starting it is normal for the overload LED to illuminate for a few seconds. If LED stays illuminated and the ready LED turns off, the engine will continue to run without output power. Remove all applied loads and determine if attached devices exceed recommended output power. Check for faulty or shorted connections. To restore electrical output, turn dial “OFF” to reset. Start engine. If condition was corrected, the orange LED will not illuminate and electrical output will be restored. Loads can be applied once the green LED illuminates. If the orange LED returns contact an ASD.
- * **LOW OIL LEVEL LED (Yellow):** Illuminates when oil level is below safe operating level. Engine shuts down (1).
- * **POWER LED (Green):** Indicates output from generator (3) (unless there is a low oil or overload condition).

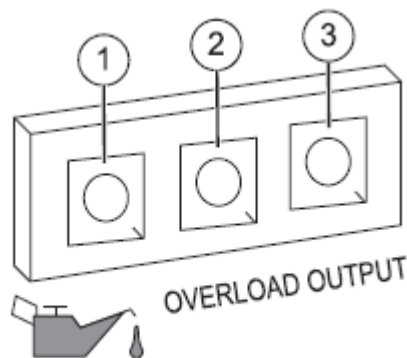

Figure-7 Status Indicators

3.5 CIRCUIT BREAKERS:

- * The AC outputs are protected by an AC circuit breaker.
- * If the generator is overloaded or an external short circuit occurs, the circuit breaker will trip. If this occurs, disconnect all electrical loads to determine the cause of the problem before using the generator again.
- * Reduce the load if the circuit breaker is tripped.
- * Continuous tripping of the circuit breaker may cause damage to generator or equipment. Push the button of the breaker to reset the circuit breaker.

4. PART: STARTING GENERATOR

- * Disconnect electrical loads prior to starting or stopping unit. Failure to do so could result in equipment and property damage.
- * Check the oil and fuel levels.
- * Check that the generator properly grounded.
- * Open vacuum relief valve on top of fuel cap. Rotate clockwise to the “ON” position.
- * Allow the generator to run for several minutes before attempting to connect any electrical devices. This allows the generator to stabilize its speed and temperature.
- * Turn the 3-in-1 switch the off/On/Choke switch to “CHOKE” (1)
- * Switch economy switch to “OFF”.
- * Recoil Starting: Firmly grasp recoil handle and pull slowly until increased resistance is felt. Pull rapidly up and away. Repeat the same steps if necessary. Never allow the cord to snap back
- * **See Figure-8.** When engine starts, rotate OFF/ON/CHOKE dial to “ON” (2). Choke operation is reduced as OFF/ON/CHOKE dial is rotate towards “ON”.
- * If engine fires, but does not continue to run, rotate the OFF/ON/CHOKE dial to “OFF” and repeat starting instructions.
- * Do not overload generator or individual panel receptacles. **See Figure-9.** If an overload occurs, the overload LED (A) will illuminate and AC output ceases. To correct see the Generator Status Lights. Read Know Generator Limits carefully.

 **ATTENTION!** Recoil Hazard. Recoil could retract unexpectedly. Kickback could result in death or serious injury.

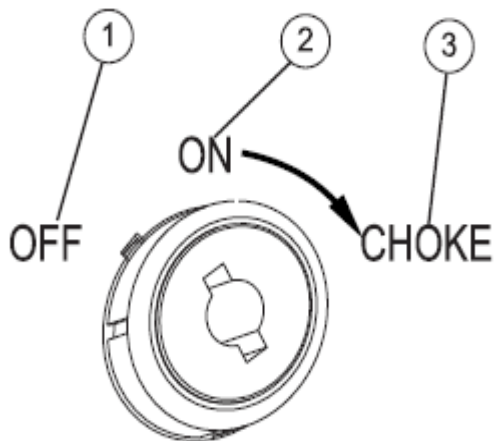

Figure-8 Off / On / Choke Positions

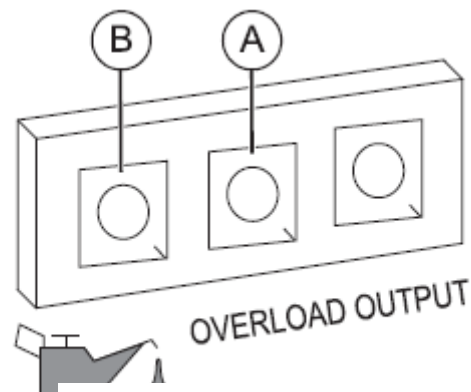

Figure-9 Shutdown Fault

4.1 GROUNDING THE GENERATOR WHEN IN USE:

- * The generator is equipped with an equipment ground connecting the generator frame and the ground terminals on the AC output receptacles.
- * This allows the generator to be used as a portable without grounding the frame of the generator. **See Figure-10.**

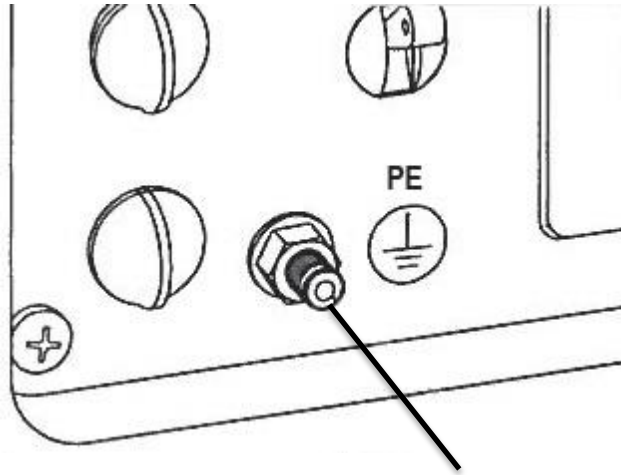

Figure-10 Grounding the Generator

- * The generator (stator winding) is isolated from the frame and from the AC receptacle ground pin.
- * Electrical devices that require a grounded receptacle pin connection will not function if the receptacle ground pin is not functional.

4.2 KNOW GENERATOR LIMITS:

- * Overloading a generator can result in damage to the generator and connected electrical devices. Observe the following to prevent overload;
 - * Add up the total wattage of all electrical devices to be connected at one time. This total should not be greater than the generator's wattage capacity.
 - * The rated wattage of lights can be taken from lights bulbs. The rated wattage of tools, appliances and motors can be found on a data label or decal affixed to the device.
 - * If the appliance, tool or motor does not give wattage, multiply volts times ampere rating to determine watts (volts*amps=watts)
 - * Some electric motors, such as induction types, require about three times more watts of power for starting than for running. This surge of power lasts only a few seconds. When starting such motors, make sure to allow for high starting wattage when selecting electrical devices to connect to the generator;
 - Figure the watts needed to start the largest motor.
 - Add to that figure the running watts of all other connected loads.
- * **Wattage Reference Guide** is provided to assist in determining how many items the generator can operate at one time.
- * All figures are approximate. See data label on appliance for wattage requirements.

Wattage Reference Guide

Device	Running Watts
*Air Conditioner (12,000 Btu)	1700
*Air Conditioner (24,000 Btu)	3800
*Air Conditioner (40,000 Btu)	6000
Battery Charger (20 Amp)	500
Belt Sander (3")	1000
Chain Saw	1200
Circular Saw (6-1/2")	800 to 1000
*Clothes Dryer (Electric)	5750
*Clothes Dryer (Gas)	700
*Clothes Washer	1150
Coffee Maker	1750
*Compressor (1 HP)	2000
*Compressor (3/4 HP)	1800
*Compressor (1/2 HP)	1400
Curling Iron	700
*Dehumidifier	650
Disc Sander (9")	1200

Edge Trimmer	500
Electric Blanket	400
Electric Nail Gun	1200
Electric Range (per element)	1500
Electric Skillet	1250
*Freezer	700
*Furnace Fan (3/5 HP)	875
*Garage Door Opener	500 to 750
Hair Dryer	1200
Hand Drill	250 to 1100
Hedge Trimmer	450
Impact Wrench	500
Iron	1200
*Jet Pump	800
Lawn Mower	1200
Light Bulb	100
Microwave Oven	700 to 1000
*Milk Cooler	1100
Oil Burner on Furnace	300
Oil Fired Space Heater (140,000 Btu)	400
Oil Fired Space Heater (85,000 Btu)	225
Oil Fired Space Heater (30,000 Btu)	150
*Paint Sprayer, Airless (1/3 HP)	600
Paint Sprayer, Airless (hand-held)	150
Radio	50 to 200
*Refrigerator	700
Slow Cooker	200
*Submersible Pump (1-1/2 HP)	2800
*Submersible Pump (1 HP)	2000
*Submersible Pump (1/2 HP)	1500
*Sump Pump	800 to 1050
*Table Saw (10")	1750 to 2000
Television	200 to 500
Toaster	1000 to 1650
Weed Trimmer	500
* Allow 3 times the listed watts for starting these devices.	

4.3 STARTING HOT ENGINES:

- * Disconnect electrical loads prior to starting or stopping unit.
- * Failure to do so could result in equipment and property damage.
- * **See Figure-8.** Turn OFF/ON/CHOKE dial from STOP to ON. This will open the fuel valve and permit starting.
- * Firmly grasp recoil handle and pull slowly until increased resistance is felt. Pull rapidly up and away.

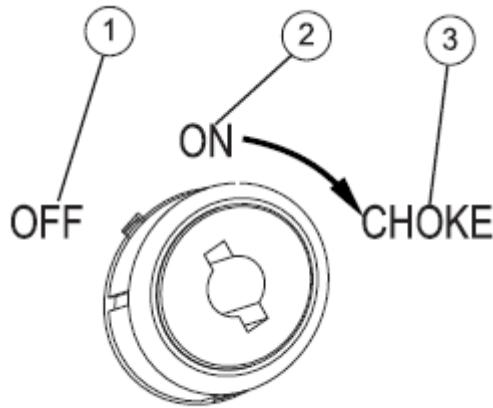

Figure-8 Off / On / Choke Positions

5 PART: STOPPING GENERATOR

- * Shut off all loads and unplug electrical loads from generator panel receptacles.
- * Disconnect electrical loads prior to starting or stopping unit. Failure to do so could result in equipment and property damage.
- * Let engine run at no-load for several minutes to stabilize internal temperatures of engine and generator.
- * Turn the 3-in-1 switch to the “OFF” position as shown on the **See Figure-8.**
- * Close vacuum relief valve on top of fuel cap. Rotate clockwise to the “OFF” position.
- * Do not use the choke to stop the engine. If “choke” used, explosion may occur due to the rich mixture. This is harmful to the engine.

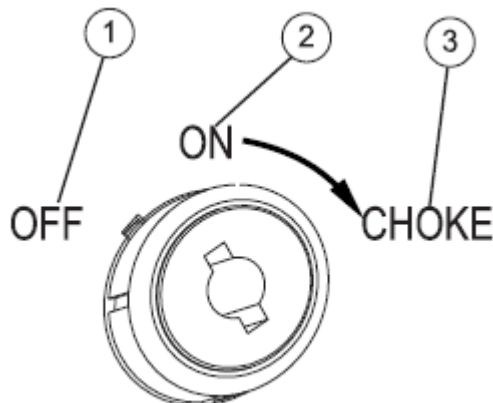

Figure-8 Off / On / Choke Positions



ATTENTION! Allow the generator to cool for several minutes before touching areas that become hot during use

6 PART: MAINTENANCE:

- * Always have authorized persons or authorized services maintain your generator set. Note that guarantee will be void in case of maintenance, repair and setting made by unauthorized services or persons.
- * Always use original spare parts in maintenance and repair. Never use non-original parts or those approved by GENPOWER in written form.
- * Guarantee of the generator set will be void as a result of damages caused by non-original maintenance or repair parts.
- * Comply with safety measures mentioned in previous sections while performing the maintenance.



ATTENTION! *When servicing your generator, disconnect the spark plug wire from the spark plug to prevent the engine from starting suddenly. Take safety precautions and follow them.*

- * Check Oil Level Regularly: Check every 5 hours of operation or daily. Make sure the oil level is just right.
- * Regular maintenance will improve performance and extend engine/equipment life.

6.1 MAINTENANCE SCHEDULE:

- * Follow maintenance schedule reversals, whichever occurs first according to use.
- * Adverse condition will require more frequent service.
- * All required service and adjustments should be each season as detailed in the following chart.
- * Dirt or debris can cause improper operation and equipment damage.
- * Clean generator daily or before each use.
- * Keep area around and behind muffler free from combustible debris.
- * Inspect all cooling air openings on generator.
- * Use a damp cloth to wipe exterior surfaces clean.
- * Use a soft bristle brush to loosen caked on dirt, oil.. etc.
- * Use a vacuum to pick up loose dirt and debris.
- * Low pressure air (not to exceed 25 psi) may be used to blow away dirt. Inspect cooling air slots and openings must be kept clean and unobstructed.
- * To maintain the product warranty, the engine oil should be serviced in accordance with the recommendations of this manual.
- * For your convenience, maintenance kits designed and intended for use on this product are available from the manufacturer that include oil filter, air filter, spark plug (s).
- * These kits can be obtained from an Authorized Service.

At Each Use
Check engine oil level
Every 100 Hours or Every 6 Months
Clean/Replace Air Filter**
Change oil ‡
Muffler Screen
Clean/Replace Spark Arrestor
Every 300 Hours or Every Season*
Replace Spark Plug
Clean Spark Arrestor
Replace Fuel Filter +
Valve Clearance Adjustment
Check/Replace Crankcase Breather Hose
Check Cylinder Head +
Check Fittings/Fasteners +
‡ Change oil after first month or 20 hours of operation. + To be performed by IASD. * Change oil every month when operating under heavy load or in high temperatures. ** Clean more often under dirty or dusty operating conditions. Replace air filter parts if they cannot be adequately cleaned. *** Check valve clearance and adjust if necessary after first 50 hours of operation and every 300 hours thereafter.

6.2 OIL CHANGE:

- * Replace oil after the first 5 hours of use.
- * Under normal operating conditions, engine oil should be changed every 50 working hour.
- * At high temperatures and loads the oil should be changed every 25 hours.
- * Change engine oil before storage.
- * Don't pollute. Conserve resources. Return used oil to collection centers.
- * Change oil while engine is still warm from running as follows;
 - Please generator on a level surface and Place generator on elevated platform such as table or desk. Put a container next to it to hold the used oil.
 - Disconnect the spark plug wire from the spark plug and place the wire where it cannot connect spark plug.
 - Remove the side panel.
 - Close vacuum relief valve on top of fuel cap. Rotate clockwise to the "OFF" position.
 - Clean area around oil fill and drain plug.
 - Remove oil fill cap and wipe dipstick clean.
 - Unscrew the dipstick and put aside.
 - Tip unit and drain oil completely into a suitable container. Once oil is sufficiently drained from unit, tip unit back to a level position.
 - Insert funnel into oil fill opening. **See Figure-11.** Add recommended engine oil as necessary.
 - To Check oil level remove funnel and insert dipstick into oil filler neck without screwing it in. **See Figure-12.**
 - Remove dipstick and verify oil level is within safe operating range.
 - Verify oil level often during filling process to ensure overfilling does not occur.

- Replace oil fill cap and hand-tighten.
- Wipe up any spilled oil.

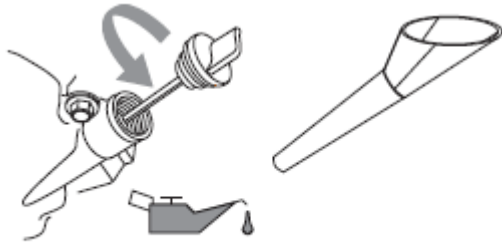
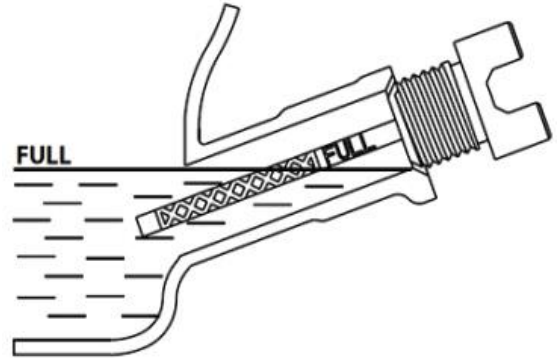

Figure-11 Oil Fill With Funnel



Figur-12 Safe Operating Range

6.3 AIR FILTER:

- * Routine maintenance of the air cleaner helps maintain proper airflow to the carburetor.
- * Occasionally check the air cleaner is free of excessive dirt.
- * Follow the next steps:
 - Remove the side panel,
 - Remove 3 screws than pull the air cleaner cartridge out,
 - Unscrew the filter attachment screws (A). **See Figure-13.**
 - Carefully remove the pre-cleaner and wash it with liquid detergent and water. And then Squeeze dry in clean cloth (DO NOT TWIST). (B). **See Figure-13.**
 - Absorb engine oil and wring out any excess oil with an absorbent cloth.
 - Clean air filter cover before installation.
 - Replace side cover and screws.

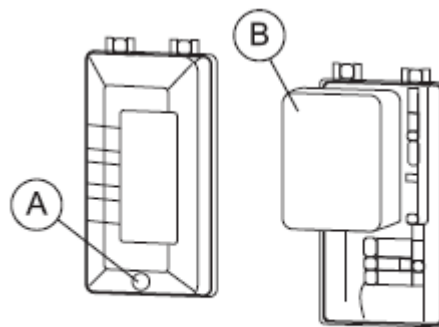

Figure-13 Air Filter Assembly

6.4 CLEANING OF GENERATOR:

- * Remove dirt and debris with a cloth or brush and clean it.
- * Water jet washing does not recommended due to engine fuel system with alternator winding and electrical equipment may break down.
- * Do not keep combustible parts on or near of exhaust muffler.
- * Generator cooling provided by the air flow passing over it. Therefore, the air ducts on the engine body and the alternator air outlet windows must be open and clean.
- * Grass and dirt can clog the starter guard and the air cooling system becomes inadequate, especially as a result of extended maintenance time.

- * Every 100 hours or every season, remove the starter guard and clean the area shown in **Figure-14**.

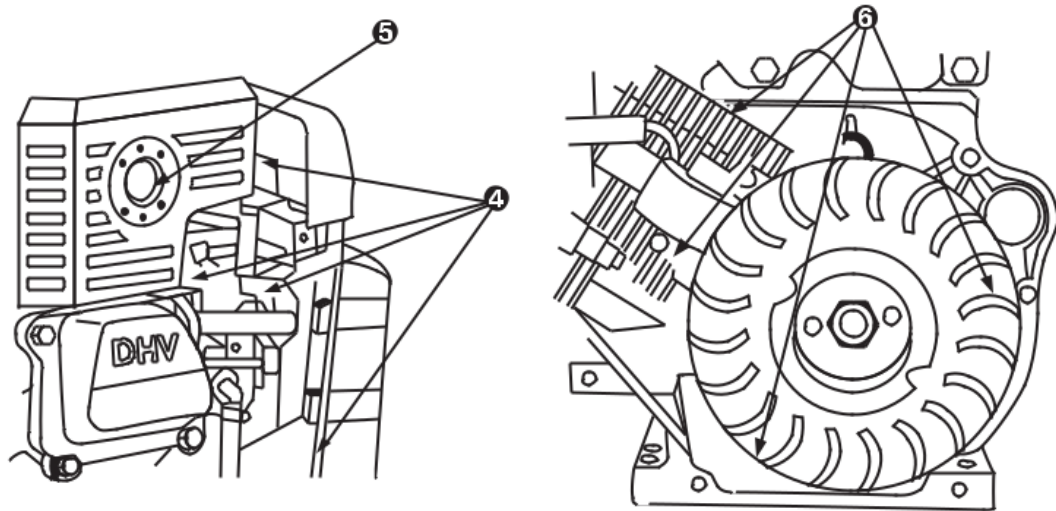

Figure-14

6.5 SPARKING PLUG REPLACEMENT OR MAINTENANCE:

- * The spark plug is important for proper engine operation,
- * A good spark plug should be intact, free of deposit and properly gapped.
- * Replace or clean the spark plug after every 100 operating hours.
- * Follow the next steps:
 - Remove side panel,
 - Remove spark plug boot, be careful not to tear insulation or wire,
 - Unscrew the spark plug from the engine using the spark plug wrench provided. There is limited space for the wrench to turn. Use both rows of holes in the spark plug wrench to gain leverage to loosen the plug,
 - Visually inspect the spark plug for cracks or excessive electrode wear. Replace as necessary.
 - Inspect electrode gap with wire feeler gauge and reset spark plug to 0.6-0.7 mm (0.024-0.028 in). **See Figure-15**
 - Clean the spark plug by scraping or with a wire brush.
 - Replace spark plug if electrodes are pitted, burned or porcelain is cracked. Use **ONLY** recommended replacement plug.
 - Screw the spark plug back into the spark plug hole using the spark plug wrench. Do not overtighten spark plug. Recommended tightening spark plug is 3/8 to 1/2 of a turn after spark plug gasket contacts spark plug hole. Reinstall the spark plug boot and control panel.

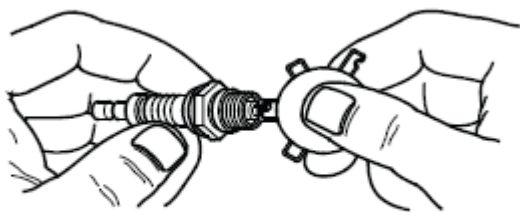

Figure-15 Spark Plug

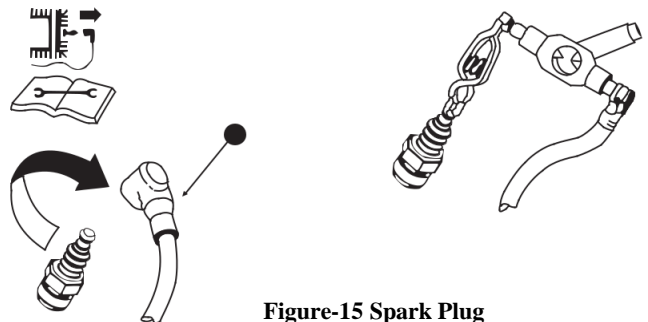

Figure-15 Spark Plug

6.6 INSPECT MUFFLER AND SPARK ARRESTOR:

- * It is prohibited to operate the engine on any forested bushland unless equipped with a spark arrestor while the exhaust system is running.
- * Contact original equipment manufacturer, retailer or dealer to obtain a spark arrestor designed for exhaust system installed on this engine.
- * Use ONLY original equipment replacement parts. Inspect muffler for cracks, corrosion, other damage. Remove spark arrestor, if equipped inspect for damage or carbon block age. Replace parts as required.

⚠ ATTENTION!! Hot surfaces. When operating machine, do not touch hot surface. Keep machine away from combustibles during use. Hot surfaces could result in severe burns or fire.

6.7 CLEAN SPARK ARRESTOR SCREEN:

- * The engine exhaust muffler has a spark arrestor screen.
- * Inspect and clean the screen every 50 hours of operation or every season, whichever comes first.
- * To service spark arrestor **See figure-16**. Remove the clamp to remove retainer.
- * Slide spark arrestor screens out from the muffler outlet tube.
- * Inspect screens and replace if torn, perforated or otherwise damaged. Do not use a defective screen. If screen is a not damaged, clean with a commercial solvent.
- * Replace the screens, retainer and secure with clamp.

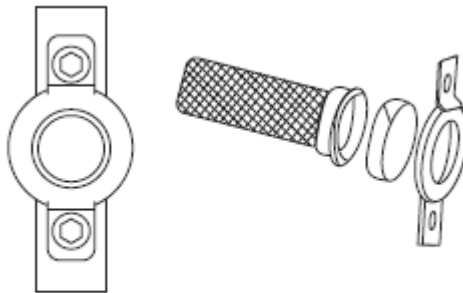

Figure-16 Spark Arrestor Screen

6.8 VALVE CLEARANCE:

- * Please contact an authorized service dealer for service assistance. Proper valve clearance is essential for prolonging the life of the engine.
- * Check valve clearance after the first fifty-hours of operation. Adjust as necessary.
- * Intake – 0.10 +/- 0.02 mm (cold), (0.004” +/- 0.001” inches)
- * Exhaust – 0.10 +/- 0.02 mm (cold), (0.004” +/- 0.001” inches)

6.9 STORAGE:

- * Risk of fire. Verify machine has properly cooled before installing cover and storing machine. Hot surfaces could result in fire.
- * It is recommended to start the generator for 30 minutes, every 30 days. If this is not possible, refer to the following list to prepare unit for storage.
- * Do not place a storage cover on a hot generator. Allow unit to cool to room temperature before storage.
- * Do not store fuel from one season to another unless properly treated.
- * Replace fuel container if rust is present. Rust in fuel will cause system problems.
- * Cover unit with a suitable protective, moisture resistant cover.
- * Store unit in a clean dry area.
- * Always store generator and fuel away from heat and ignition sources.

6.10 PREPARE FUEL SYSTEM/ENGINE FOR STORAGE:

- * Fuel stored over 30 days can go bad and damage fuel system components.

- * Keep fuel fresh, use fuel stabilizer.
- * If fuel stabilizer is added to fuel system, prepare and run engine for long term storage
- * Run Engine for 10-15 minutes to circulate stabilizer throughout fuel system. Adequately prepared fuel can be stored up to 24 months.
- * If fuel has not been treated with fuel stabilizer, it must be drained into an approved container. Run engine until it stops from lack of fuel. Use of fuel stabilizer in fuel storage container is recommended to keep fuel fresh.
- * Change engine oil.
- * Remove spark plug.
- * Pour tablespoon (5-10 cc) of clean engine oil or spray a suitable fogging agent into cylinder.
- * Pull starter recoil several times to distribute oil in cylinder.
- * Install spark plug.
- * Pull recoil slowly until resistance is felt. This will close valves so moisture cannot enter engine cylinder. Gently release recoil.

7. PART: MONO PHAZE GENERATOR CONNECTION DIAGRAM

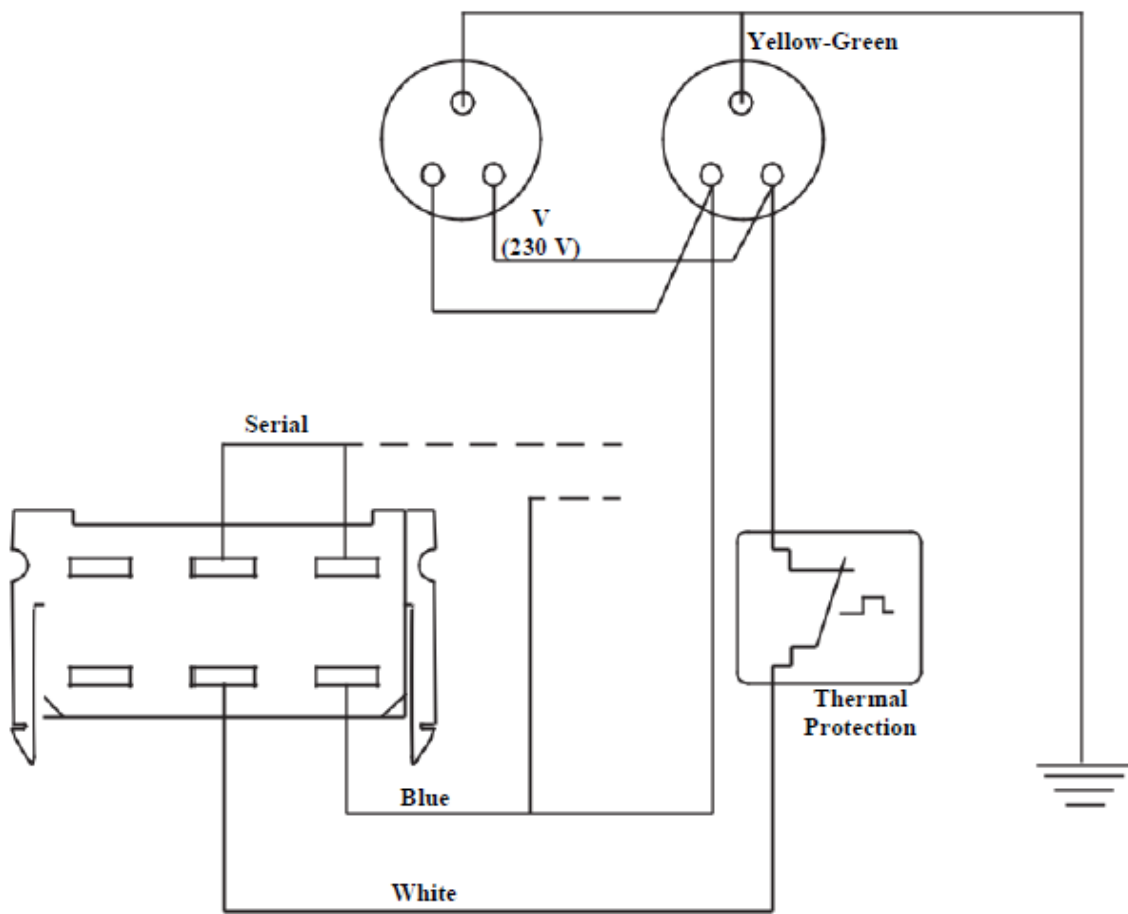

Figure-17

Troubleshooting

PROBLEM	CAUSE	CORRECTION
Engine won't start.	<ol style="list-style-type: none"> 1. Dial turned off. 2. Out of fuel. 3. Defective spark plug. 4. Plugged fuel filter. 5. Defective or stuck Dial assembly. 6. Incorrect engine oil level. 7. Defective ignition coil. 8. Fuel cap vent OFF. 9. Carb is flooded. 10. Throttle plate closed. 	<ol style="list-style-type: none"> 1. Turn on Dial. 2. Fill fuel tank. 3. Replace spark plug. 4. Replace fuel and fuel filter. 5. Contact IASD. 6. Check/fill engine oil. 7. Contact IASD. 8. Turn fuel cap vent ON. 9. Drain carb. 10. Open throttle plate (push toward back of unit).
Engine starts, then shuts down.	<ol style="list-style-type: none"> 1. Out of fuel. 2. Incorrect engine oil level. 3. Contaminated fuel. 4. Defective low oil level switch. 	<ol style="list-style-type: none"> 1. Fill fuel tank. 2. Check engine oil level. 3. Contact IASD. 4. Contact IASD.
Engine will not start; or starts and runs rough.*	<ol style="list-style-type: none"> 1. Choke is stuck or left on. 2. Dirty or clogged air filter. 3. Defective or dirty spark plug. 4. Dirty fuel filter. 5. Dirty or gummed up carburetor. 6. Unit not warmed up. 7. Spark arrestor clogged. 	<ol style="list-style-type: none"> 1. Turn choke off. 2. Clean or replace air filter. 3. Replace spark plug. 4. Replace fuel and fuel filter. 5. Clean carburetor. 6. Gradually adjust Dial and reduce choke until engine runs smoothly in RUN position. 7. Clean spark arrestor.
No AC output.	<ol style="list-style-type: none"> 1. Generator is overloaded. 2. Inverter module is overheated. 3. Short circuit in electrical device. 4. Defective inverter assembly. 	<ol style="list-style-type: none"> 1. Disconnect all loads. Shut down generator to reset module. Reduce loads, restart generator. 2. Verify service door is ON. Let cool 15 minutes by running engine without AC output. Press and hold Reset button on control panel, restart generator. 3. Verify condition of extension cords and items being powered. Press and hold Reset button on control panel. 4. Contact IASD.
Fuel leaks from drain hoses.	<ol style="list-style-type: none"> 1. Carburetor drain in bowl is not closed. 	<ol style="list-style-type: none"> 1. Turn valve clockwise to close.
* Engine speed increases and decreases — This is normal as generator starts up and loads vary.		

THANK YOU FOR CHOOSING GENPOWER GENERATOR SETS, WE WISH FOR YOU TO USE YOUR GENPOWER GENERATOR THROUGH LONG AGES IN ACCORDANCE WITH THESE OPERATING AND MAINTANCE MANUAL.

GENPOWER[®]
GENERATOR



GENERAL DIRECTORATE

ASO II. Industrial Zone
2010. Street No: 18
06909 Temelli-Sincan/Ankara, TURKEY
Phone/ Fax: +90(312) 641 32 22 - 641 32 23
genpower@genpower.com.tr
www.genpower.com.tr